



SCC800TB

Telescopic Boom Crawler Crane 80 Tons Lifting Capacity

Quality Changes the World



- Max. lifting moment: 300t·m
- Max. boom length: 47m
- Max. boom + jib length: 47m+17.5m

The parameters and diagrams in the brochure are only for reference, which are subject to further update in real machine.

■ www.sanyglobal.com



Telescopic Boom Crawler Crane
SCC800TB

P03

Major Specifications

- Product Specification
- Safety Device

P08

Technical Parameters

- Major Performance & Specifications
- Outline Dimension
- Transport Dimension
- Transport Plan

P15

Cofigurations

- Working range of H
- Load Chart of H
- Load Chart of Jib



SCC800TB
TELESCOPIC BOOM CRAWLER CRANE
80 TONS LIFTING CAPACITY

QUALITY CHANGES THE WORLD

Major Specifications

- Page 04 Product Specification
- Page 07 Safety Device



Product Specification



Engine

- Model: ISUZU 6HK1XKJC-01 Diesel engine;
- Type: 4 cycle, water-cooled, vertical in-line 6, direct injection, turbo-charger, intercooler, complied with European Off-way Tier III Emission standard and Chinese Off-way Tier III Emission standard;
- Displacement: 7.79L;
- Rated power: 212kW/2000rpm;
- Operation power: 200kW/1800rpm;
- Max. Torque: 1080N·m/1500rpm;
- Cooling System: Water-cooled;
- Starter: 24V-5.0kW;
- Radiator: fin type core in aluminum;
- Air cleaner: Dry type main filter element, safety element core and resistance indicator;
- Throttle: Grip type hand throttle, electrically controlled;
- Fuel filter: Replaceable paper element;
- Batteries: Two 12V×165Ah capacity batteries, connected in series;
- Fuel tank capacity: 400L.

Electrical control system

- SANY developed SYIC-II integrated control system is adopted with high integration, precise operation and reliable quality;
- Control system consists of power system, engine, main control system, LMI system, auxiliary system and safety monitoring system;
- CAN BUS is used for data communication between controller, monitor and the engine;
- Monitor: the working parameters and status are shown on the monitor, such as the engine speed, fuel volume, engine oil pressure, servo pressure, wind speed, engine working hours, lifting conditions and boom angle.

Hydraulic system

- Main pumps: open variable displacement piston pumps of large displacement is adopted to provide oil supply for main actuators of main machine;
- Gear pump: dual gear pump for swing, radiator and control circuit;
- Control: main pump adopts electrically-controlled positive flow control, winch motor adopts limitless adjustable piston motor of variable displacement. The operating components are two cross hydraulic handle, one hydraulic pedal for telescopic boom, one dual travel pedal control valve to control various actuator proportionally;
- Way of cooling: heat exchanger, fan core and multi-stage cooling;
- Filter: large flow, high precision filter, with bypass valve and transmitter, which can remind the user to replace the filter element in time;
- Max. pressure of system:
Main/aux. load hoist and travel system: 32Mpa;
Boom hoist cylinder: 32 MPa;
Swing system: 24 MPa;
Control system: 4.5 MPa;
- Hydraulic Tank Capacity: 950L.

Main/aux. load hoist mechanism

- Pump and motor: dual variable displacement with speed adjustable, to realize higher efficiency and lower down the energy. Winch balance valve combined with anti-hook sliding technology can make sure the load lifting steady;
- Winch brake adopts wet type and spring loaded fin type normally engaged brake, spring force braking, oil pressure released;
- Main and aux. load hoist system adopts piston motor of variable displacement to drive planetary gearbox.

Main Load Hoist Winch	Rope speed on the outermost layer	0 ~ 140m/min
	Wire rope diameter	Φ22mm
	Wire rope length	245m
	Rated single line pull	8.0t

Axu. Load Hoist Winch	Rope speed on the outermost layer	0 ~ 140m/min
	Wire rope diameter	Φ22mm
	Wire rope length	145m
	Rated single line pull	8.0t



Product Specification

Boom hoist mechanism

- dual-acting single piston hydraulic cylinder, with safety balance valve, and a luffing angle of $-1.5^{\circ} \sim 80^{\circ}$. Luffing down through self-weight to reduce energy consumption and increase stability of luffing down operation.

Swing mechanism

- Swing brake adopts wet, spring loaded, normally-closed brake, and braking through spring force;
- Swing system, equipped with integrated swing buffer valve, has free slipping function. It is featured in steady start, control and excellent inching function;
- Unique swing buffer design and more steady brake;
- Swing drive: external gear swing drive with 360° swing range, and the max. swing speed is 2r/min. The max. drive pressure can reach 20MPa;
- Swing lock: cylinder lock device can make sure the upperworks can be locked on four directions after the work is done or during transport, which is more convenient and reliable;
- Swing ring: single row ball bearing.

Counterweight

- Counterweight are designed into blocks for self-assembly and easier transport;
- Counterweight tray and blocks are piled up for easier assembly and transport;
- Rear counterweight: total 26t and capable of self-assembly;
- Carbody counterweight: 3t×2 at the front and rear of carbody.

Upperworks

- High-strength steel weld framework, with no torsion or deformation. The parts are laid out in the way that is easier for maintenance and service.

Cab and control

- Novel operator's cab is bright with ample space, providing wider view and can tilt 20° . There are low and high-beam lights, back-view mirror, heater and A/C, radio and other functions. The layout of seat, handles, control buttons are designed with ergonomic principles to make operation more comfortable;
- Cab layout: Integrated 10.4-inch touch screen, programmable smart switches, vibration handles are offered as optional and man-machine interaction interface are more perfect;
- Armrest box: on the left and right armrest box are control handles, electrical switches, emergent stop and ignition switch. The armrest box can be adjusted along with the seat;
- Seat: multi-way and multi-level floating adjustable seat with unload switch;
- A/C: cool and heat air; optimized air channels and vents;
- Multiple cameras can be presented on the monitor at the same time to realize real-time monitoring of wire rope on each winch, conditions behind the counterweight and surrounding the machine.

Product Specification



Travel drive

- Independent travel driving units are adopted for each side of the crawler, to realize straight walking and turning driven by travel motor through gearbox and drive wheel;
- There are high-speed and low-speed for travel as fast as 2.5km/h;
- Gradeability is 30%.

Travel brake

- Embedded, wet, spring-loaded and normally-closed brake, which is braking with spring force and released by oil pressure.

Crawler extension and retraction

- The crawlers can extend and retract under high pressure provided by auxiliary system and electrically-controlled cylinder. During normal operation, the crawlers must be extended, and can be retracted during transport to stay on the machine.

Crawler tensioning

- The jack is used to push the guide wheel and insert the shim to adjust crawler tension.

Steering system

- The machine is capable of pivot turning and single track turning.

Track pad

- High-strength alloy cast steel track pad can prolong the service life. They are 850mm wide, and the total amount is 52pcs x 2.

Track roller

- Maintenance-free track roller.

Outrigger

- Outrigger cylinder is offered to facilitate the track frame disassembly during jobsite transfer.

Boom

- The boom is made of high-strength steel structure with U-shape section area, with five sections, of which the basic boom is 12.2m and the total length is 47m;
- Dual cylinder full power rope row telescoping.

Fixed jib

- Two lengths of fixed jib, 10.2m and 17.5m, each can be installed in angle 0°, 15°, 30°.

Boom point sheave block

- Weld structures, connected to the boom through pins and used for aux. hook.

Hook block

SN	Load Capacity (t)	Sheave block	Weight (t)	QTY
1	80	5	1.05	1
2	45(optional)	1	0.48	1
3	15(optional)	1	0.34	1
4	8	1	0.16	1

- Note: the above-mentioned operating equipment is full-up configuration. The actual configurations are subject to contract.

Hook limitation height

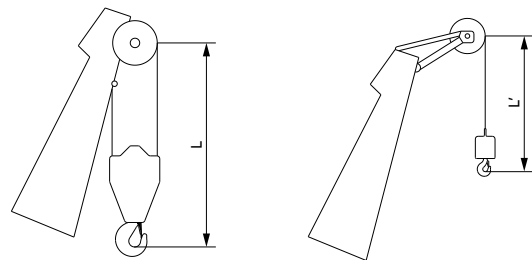

Hook	L	Hook	L'
80t	3.5m	8t	3m



Safety Device

Integrated LMI control system

- LMI control system is standard offering and it is calibration-free. It ensures the operation safety and improves efficiency;
- LMI system can automatically detect the load weight, working radius and boom angle, to compare with rated load weight and actual load, work radius and boom angle. In normal operation, it can make judgment and cut off the actions towards dangerous directions. It also acts as black box to record overload information;
- Composition: monitor, controller, length and angle sensor, pressure sensor.

Assembly/work mode control switch

- In Assembly Mode, the over-hoist protection, LML are all off work to facilitate crane assembly;
- In Work Mode, all safety devices activate to protect the operation.

Emergent Stop

- In emergent situation, this button is pressed down to cut off the power supply of whole machine and all actions stop.

Over-hoist Protection of the Main/ Auxiliary Hooks

- Height limit device is installed at the tip of main boom and jib, which prevents the hook lift up too much. When the hook lifts up to the limit height, the limit switch activates, buzzer on the left control panel sends alarm, and failure indicator light starts to flash, the hook hoisting action is cut off automatically.

Over-release Protection Device of the Main/Auxiliary Winch

- Three-wrap protector is installed on main and aux. load hoist winches to prevent over-release of wire rope. When the rope is paid out close to the last three wraps, the limit switch acts, and the system sends alarm through buzzer and show the alarm on the instrument panel, automatically cutting off the winch action.

Function Lock

- If the function lock level is not in work position, all the other handles won't work, which prevents any mis-operation caused by accidental collision.

Swing Lock

- Electrical lock is equipped, and swing action can only happen when the lock is released, so as to prevent any operational error and ensure the safety;
- The cylinder lock can lock the upperworks at four directions.

Hook Latch

- The lifting hook is installed with a baffle plate to prevent wire rope from falling off.

Monitoring System

- Remote Monitoring system is a standardized offering to provide functions like GPS locating, GPRS data transfer, machine status inquiry and statistics, operating data monitoring and analysis, remote diagnosis of failures.

Tri-color Load Indicator

- The load indication light has three colors, green, yellow and red, indicating the real-time load. When the actual load is smaller than 90% of rated load, the green light is on;
- When the actual load is $>90\%$ and $\leq 100\%$, the yellow light is on, the alarm light flashes and sends out intermittent sirens;
- When the actual load reaches 100% of rated load, the red light on, the alarm light flashes and sends out continuous sirens;
- When the actual load is 102% of rated load, the system will automatically cut off the crane's dangerous operation.

Flash Alarm

- When the LMI system is powered on, the flash alarm starts to flash.

Swing Indicator Light

- The swing indicator light flashes during traveling or swing.

Seat interlock protection

- If the operator leaves the seat, all control handles will be locked immediately to prevent any mis-operation due to accidental collision.

Illuminating Light

- The machine is equipped with, low-beam light in front of machine, lamps in operator's cab and boom lights, so as to increase the visibility during work.

Rearview Mirror

- It is installed on the front of the operator's cab and the handrail of the right platform and the winch.

Electronic Level Gauge

- It can show the upperworks tipping angle on the monitor.

Monitor system

- Two cameras and illumination lights are installed on the tail of rotating bed, which will show the conditions on the rear and winches on the monitor.

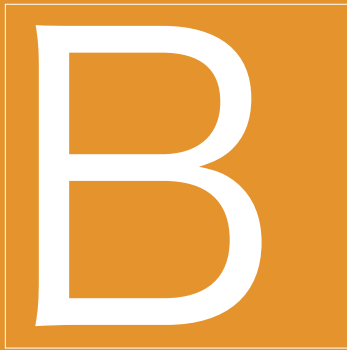

SCC800TB
TELESCOPIC BOOM CRAWLER CRANE
80 TONS LIFTING CAPACITY

QUALITY CHANGES THE WORLD

Technical Parameters

- Page 09 Major Performance & Specifications
- Page 10 Outline Dimension
- Page 11 Transportat Dimension
- Page 14 Transport Plan

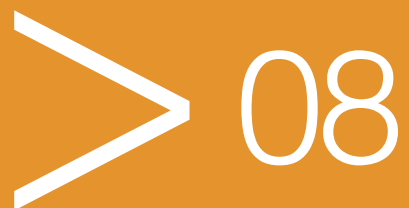

Major Performance & Specifications

Major Performance & Specifications of SCC800TB			
Performance indicators		Unit	Parameter
Outline dimension	Machine length	mm	15170
	Machine width (retracted)	mm	5100 (3490)
	Machine height	mm	3670
	Distance of centers between drive and idle wheels	mm	5436
	Track shoe width	mm	850
Boom configuration	Maximum rated load capacity	t	80
	Boom length	m	12.2~47
	Boom angle	°	-1.5~80
	Max. rated load moment	t·m	300
Jib configuration	Longest boom + longest jib	m	47+17.5
	Boom to jib angle	°	0、15、30
Operation speed	Rope speed of main/aux. load hoist	m/min	0~140
	Boom full up/down duration	s	60/105
	Boom full extension/retraction duration	s	100/125
	Swing speed	rpm	0~2
	Travel without load	km/h	0~2.5
Engine	Engine	-	ISUZU 6HK1XKJC-01
	Rated power	kW/rpm	212/2000
Wire rope	Diameter	mm	Φ22
Transport parameter	Machine weight	t	87.7
	Weight of largest single piece	t	36 (dismantling main and auxiliary hook)
	Transport dimensions of basic crane (dismantling crawler frame) length×width×height	mm	14660×3000×3100
Other parameters	Average ground bearing pressure (base boom)	MPa	0.09
	Min. swing radius	mm	4500

Outline Dimension

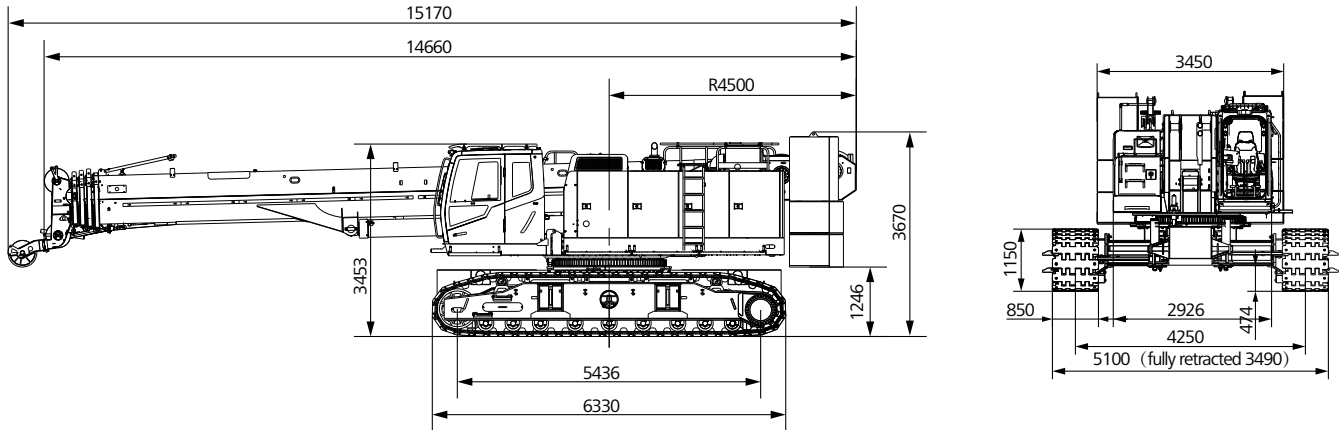

Transport Dimension

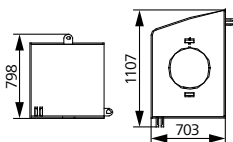
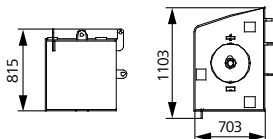
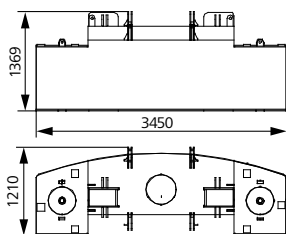
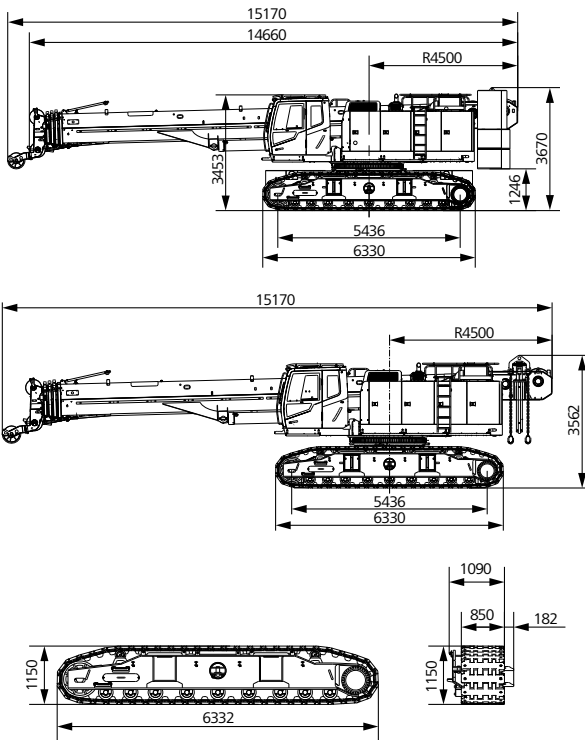

Whole Machine ×1

Length (L)	15.17m
Width (W)	3.49m
Height (H)	3.67m
Weight	87.7t

Basic Machine (with jib) ×1

Length (L)	15.17m
Width (W)	3.49m
Height (H)	3.56m
Weight	56.7t

Track Frame ×2

Length (L)	6.33m
Width (W)	1.09m
Height (H)	1.15m
Weight	9.35t

Counterweight Tray ×1

Length (L)	3.45m
Width (W)	1.21m
Height (H)	1.37m
Weight	16.5t

Rear Counterweight 1 ×2

Length (L)	0.70m
Width (W)	1.10m
Height (H)	0.82m
Weight	2.4t

Rear Counterweight ×2

Length (L)	0.70m
Width (W)	1.11m
Height (H)	0.80m
Weight	2.4t

Transport Dimension

Remarks:

- ① . The transport dimensions of each part in the table are schematic, not proportional to the real parts. The dimensions are designed value without packing.
- ② . The Weight is designed value that the actual manufactured part may deviate a little. The total weight of counterweight is 26t.
- ③ . The above dimensions and weight is subject to change due to product upgrading.

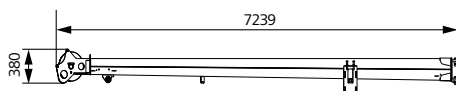
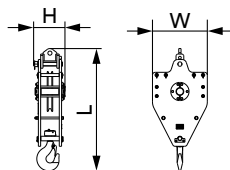
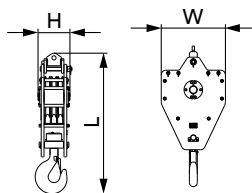
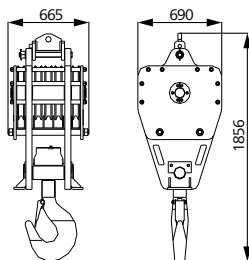
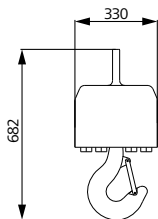
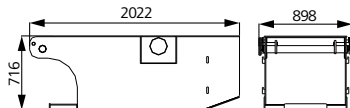

Carbody Counterweight

×2

Length (L)	2.02m
Width (W)	0.89m
Height (H)	0.72m
Weight	3.0t

8t Hook Block

×1

Length (L)	0.68m
Width (W)	0.33m
Height (H)	0.33m
Weight	0.16t

80t Hook Block

×1

Length (L)	1.86m
Width (W)	0.69m
Height (H)	0.66m
Weight	1.0t

45t hook (optional)

×1

Length (L)	1.52m
Width (W)	0.69m
Height (H)	0.37m
Weight	0.48t

15t hook (optional)

×1

Length (L)	1.34m
Width (W)	0.60m
Height (H)	0.34m
Weight	0.34t

7m Swing-away (optional)

×1

Length (L)	7.24m
Width (W)	0.38m
Height (H)	0.51m
Weight	0.26t

Transport Dimension

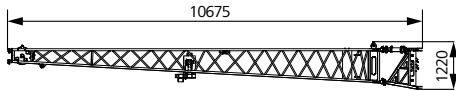

10m Jib Section (optional)

×1

Length (L)	10.08m
Width (W)	0.76m
Height (H)	1.22m
Weight	0.69t

Technical Parameters

Trailer 1	
Part (s)	▪ Basic machine
Weight	▪ 36t

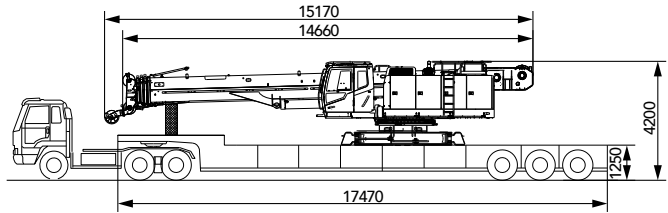

Trailer 2	
Part (s)	▪ Rear counterweight 26t ▪ Spare parts box 0.5t
Weight	▪ 26.5t

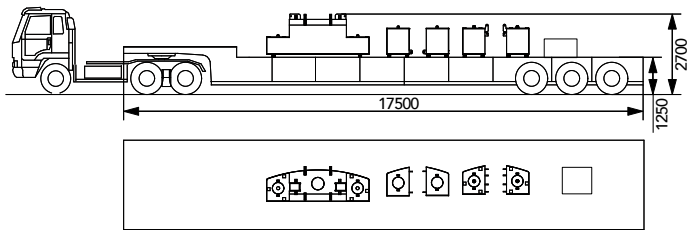

Trailer 3	
Part (s)	▪ Jib 1t ▪ Carbody counterweight 6t ▪ Left and right crawlers 18.7t ▪ 80t hook 1.0t ▪ 45t hook 0.48t ▪ 8t hook 0.16t ▪ Rear counterweight self-assembly 0.6t
Weight	▪ 27.94t

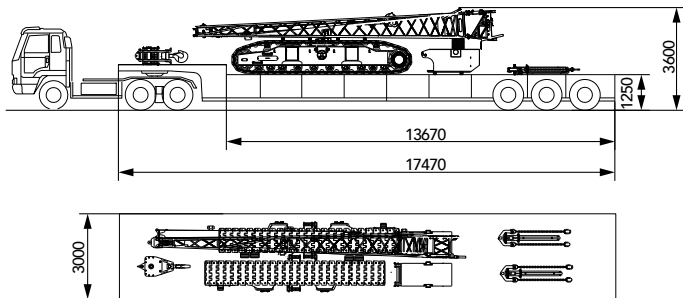



SCC800TB
TELESCOPIC BOOM CRAWLER CRANE
80 TONS LIFTING CAPACITY

QUALITY CHANGES THE WORLD

Cofigurations

- Page 16 Working range of H
- Page 17 Load Chart of H
- Page 18 Load Chart of Jib

> 15

Working range of H

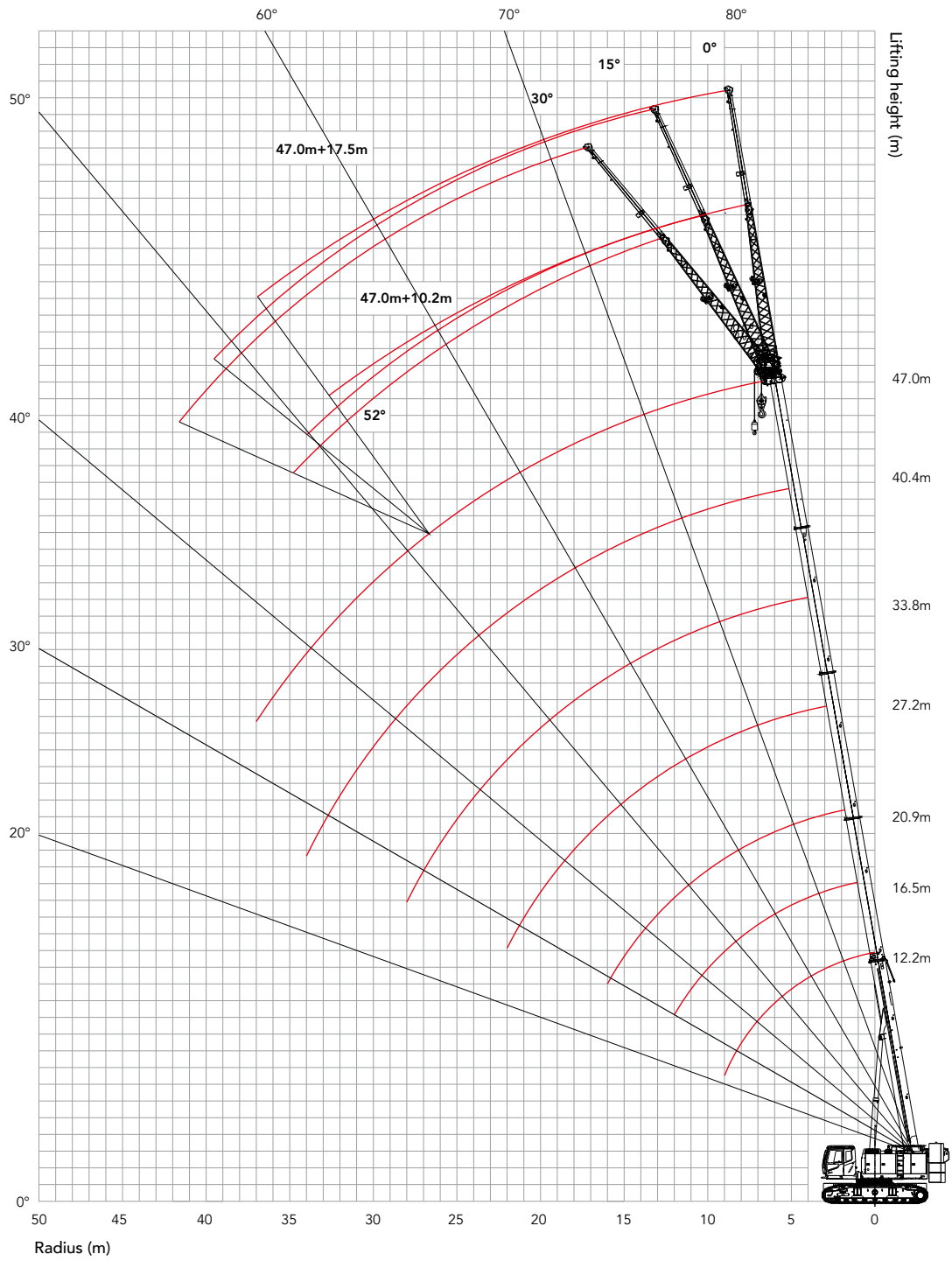

Unit: t

Load Chart of H

H Configuration load chart								
Radius (m)	Rear Counterweight is 26t, Carbody Counterweight 6t							Radius (m)
	12.2	16.5	20.9	27.2	33.8	40.4	47.0	
3.0	80.0	65.0						3.0
3.5	75.0	63.0						3.5
4.0	68.0	61.5	44.0					4.0
4.5	65.0	60.0	43.0					4.5
5.0	58.0	55.5	42.5	30.0	26.0			5.0
5.5	54.0	50.0	39.6	30.0	25.0			5.5
6.0	50.3	47.0	39.3	30.0	24.0	20.0		6.0
7.0	40.3	40.0	34.8	28.0	22.5	18.0		7.0
8.0	32.4	32.1	30.5	26.5	21.4	17.2		8.0
9.0	26.8	26.6	26.3	24.3	20.5	16.0	11.7	9.0
10.0		22.4	22.1	21.7	19.6	15.3	11.5	10.0
11.0		19.2	18.5	19.3	16.2	13.6	10.7	11.0
12.0		16.7	15.6	17.5	15.0	12.5	10.6	12.0
14.0			11.6	13.3	12.5	11.7	10.2	14.0
16.0			8.8	10.2	10.6	10.0	9.7	16.0
18.0				8.0	8.4	8.9	8.1	18.0
20.0				6.4	6.9	7.3	7.3	20.0
22.0				5.2	5.7	6.1	6.2	22.0
24.0					4.6	5.0	5.4	24.0
26.0					3.8	4.1	4.6	26.0
28.0					3.1	3.4	3.9	28.0
30.0						2.8	3.4	30.0
32.0						2.3	2.8	32.0
34.0						1.8	2.4	34.0
36.0							1.8	36.0
Parts of line	11	10	8	6	5	4	3	Parts of line
Min. Angle						26°	33°	Min. Angle
Telescoping Status (%)								
Telescoping Cylinder	I	I	I	I II	I II	I II	I II	Telescoping Cylinder
Section 2	0	50	100	100	100	100	100	Section 2
Section 3	0	0	0	25	50	75	100	Section 3
Section 4	0	0	0	25	50	75	100	Section 4
Section 5	0	0	0	25	50	75	100	Section 5

Load Chart of Jib

FJ Configuration load chart							
Boom operation angle	Rear Counterweight is 26t, Carbody Counterweight 6t						Boom operation angle
	47+10.2m Jib			47+17.5m Jib			
	0°	15°	30°	0°	15°	30°	
80°	5.5	3.8	3.3	3.3	2.0	1.5	80°
78°	5.2	3.8	3.2	3.0	1.9	1.3	78°
76°	4.9	3.7	2.9	2.7	1.8	1.3	76°
74°	4.2	3.5	2.7	2.3	1.7	1.2	74°
72°	3.6	3.3	2.6	2.1	1.6	1.2	72°
70°	3.9	3.1	2.4	1.9	1.5	1.1	70°
68°	3.5	2.9	2.3	1.8	1.4	1.1	68°
66°	3.1	2.7	2.2	1.7	1.3	1.0	66°
64°	2.7	2.5	2.1	1.6	1.2	1.0	64°
62°	2.3	2.3	2.0	1.5	1.1	1.0	62°
60°	2.0	2.0	1.8	1.4	1.0	0.9	60°
58°	1.8	1.7	1.4	1.2	0.9	0.9	58°
56°	1.6	1.4	1.2	1.1	0.9	0.8	56°
54°	1.2	1.1	1.0	0.9			54°
52°	0.9						52°
Min. protection angle	52°						Min. protection angle

Note: rated capacity of crane

1. The rated load in the load chart is calculated complying with EN13000.
2. The crawlers of crane must be extended during lifting.
3. All ratings in the table are calculated when the machine is sitting on firm and level ground with less than 1% gradient, and the load lifting is slowly and steadily.
4. All ratings in the table are calculated with wind speed under 9.8m/s and tipping load of 75%.
5. All ratings in the table are valid for 360° swing.
6. The rated load is no more than 5.5t when using boom point sheave block. If the jib is extended, the boom rated load shall reduce 2.3t.
7. The ratings in the table include the weight of hook block and riggings (main hook block of 1.05t, aux. hook block of 0.35t). The weight of hook, riggings and wire ropes shall be deducted from the ratings to get the actual load capacity.



Zhejiang SANY Equipment Co., Ltd.

SANY Industrial Park, No. 2087 Daishan Road, Wuxing District, Huzhou City,
Zhejiang Province, P. R. of China Zip 313028
After-sales Service 400 887 8318
Consulting 400 887 9318

— Agent information —

Due to updated technology, the technical parameters and configurations are subject to change without prior notice. The machine in the picture may include additional equipment. This album is for reference only, subject to the object.
All rights reserved for Sany, without the written permission of Sany, the contents of any part of this content shall not be copied or copied for any purpose.

© Printed in November 2021 in China

www.sanyglobal.com



Please scan the official WeChat account of Sany for more information.